

8

7

6

5

4

3

2

1

D

C

B

A

D

C

B

A

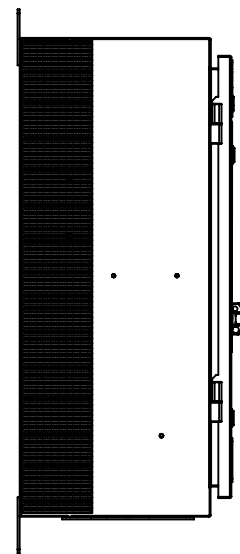

LEFT VIEW

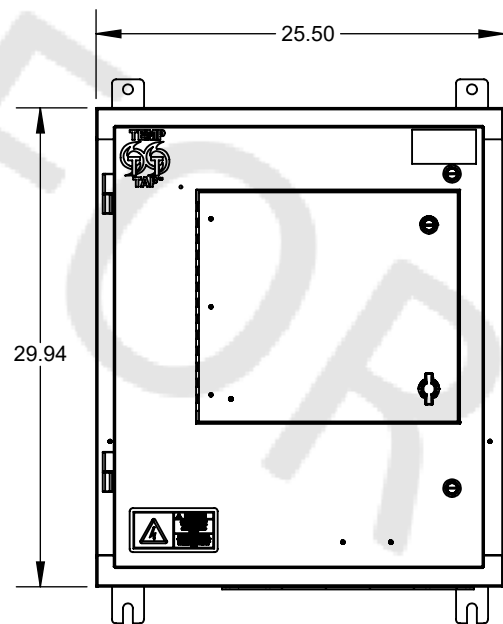

FRONT VIEW

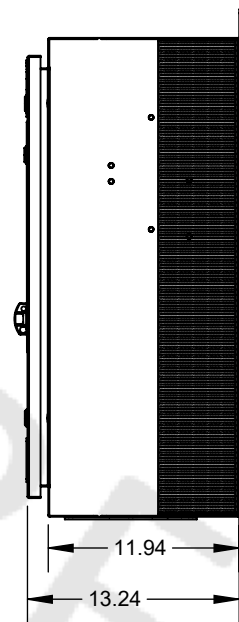

RIGHT VIEW

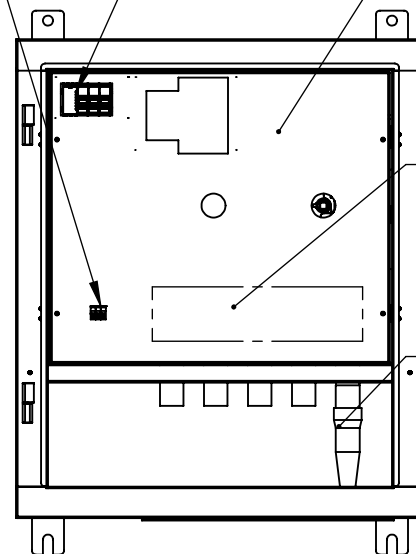

FRONT VIEW (DOORS REMOVED)

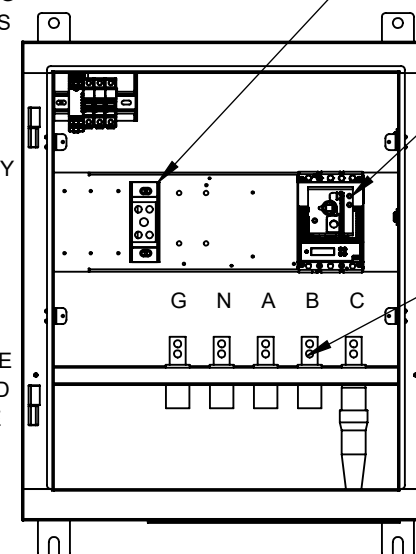

FRONT VIEW (DOORS & DEADFRONT REMOVED)

TERMINAL BLOCK STRIP
REMOTE START/STOP
(STANDARD)

PHASE ROTATION MONITOR
& FUSES (STANDARD)

DEADFRONT FOR OPERATOR
SAFETY WHILE CONNECTING
AND DISCONNECTING
GENERATOR CABLES

NEUTRAL LUG

70A-200A
DISCONNECT
LABELED "GENERATOR"

400A, 600V RATED
SINGLE POLE MALE
RECEPTACLES
COLOR CODED:
PER VOLTAGE

G N A B C

OPERATOR & SAFETY
INSTRUCTIONS

GENERATOR FEMALE
PLUG NOT INCLUDED
(SHOWN FOR SCALE
PURPOSES ONLY)

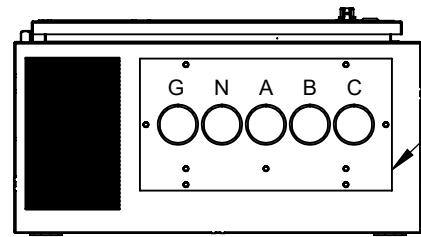

BOTTOM VIEW

HINGED INTERNAL
PROTECTIVE COVER
FOR WIRE OPENING

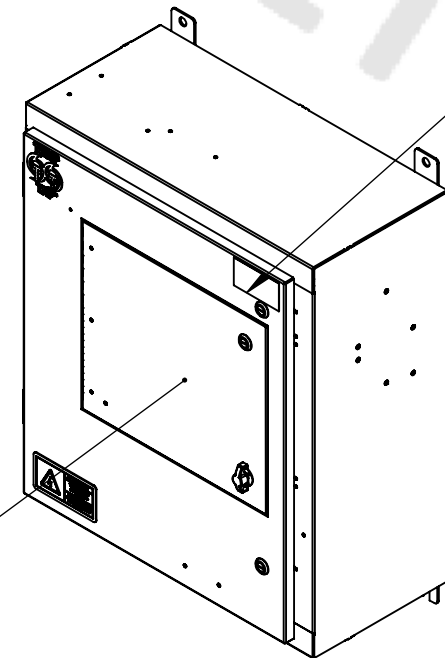

ISOMETRIC VIEW

PRODUCT LABEL

PADLOCKABLE
HANDLE COVER



TABLE OF KAIC RATINGS

DISCONNECTS	SHORT CIRCUIT RATING
SWITCH	10KA
CIRCUIT BREAKER	22KAIC

NOTES:

- STANDARD UNIT IS NON-SWITCHED NEUTRAL. FOR SWITCHED NEUTRAL PLEASE CONSULT FACTORY.
- FINISH POWDER COATED SERIES W49. SEE TITLE BLOCK FOR COLOR.
- TYPE 3R CONSTRUCTION
- NOT FOR INDOOR USE
- OPTIONAL PLUG KITS AVAILABLE
- CONDUIT ENTRY AREA SHOWN SHADED
- FOR AVAILABLE ACCESSORIES & OPTIONS SEE SPEC SHEET
- FOR SINLGE LINE VISIT WWW.ESLPWR.COM

REV.	BY	DATE	DESCRIPTION
0	AD	04/21/23	FOR REFERENCE
			DESCRIPTION
CREATED BY		AD	UNLESS OTHERWISE SPECIFIED: DIMENSIONS ARE IN INCHES TOLERANCES: DECIMALS .x ±.03 .XX ±.01 .XXX ±.005 ANGULAR ± 1/2° BREAK ALL SHARP EDGES .005 - .010 DO NOT SCALE PROPRIETARY THIS DOCUMENT AND THE DATA DISCLOSED HEREIN OR WHEREWITH IS NOT TO BE REPRODUCED, USED OR DISCLOSED IN WHOLE OR IN PART TO ANYONE WITHOUT THE PERMISSION OF ESL.
SCHEMATIC #:		0901-####	
THICKNESS:		14GA	
MATERIAL:			
FINISH:		WRINKLE GRAY (RAL7035)	ESL CORONA, CALIFORNIA International: +1 (951) 739-7000 Phone: (800) 922-4188 eslpwr.com info@eslpwr.com
REFERENCE:			
			TEMP TAP ENCLOSURE RATED 200A
		DWG NO.	4620-SERIES-A
		REV.	0
		WEIGHT:	118 lbs.
		SHEET 1 of 1	

8

7

6

5

4

3

2

1