

D

C

B

A

D

C

B

A

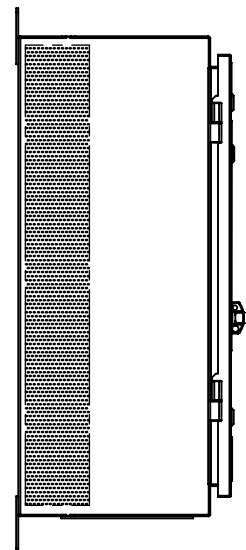

SIDE VIEW

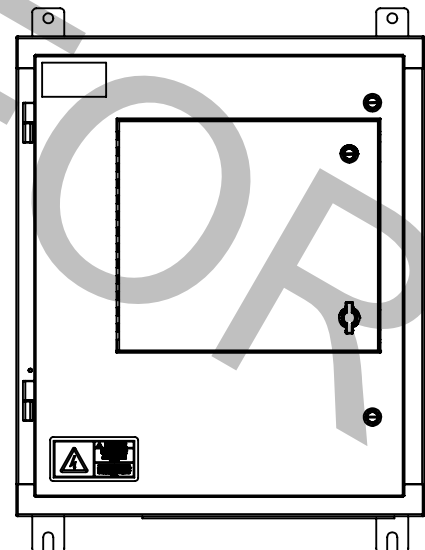

FRONT VIEW
(HANDLE COVER NOT SHOWN)

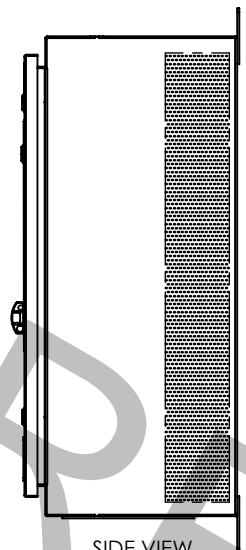

SIDE VIEW

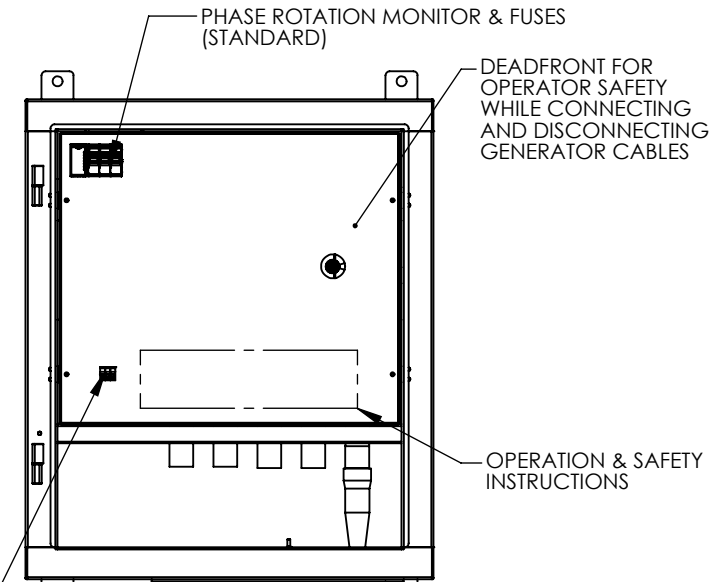

FRONT VIEW
(DOOR REMOVED)

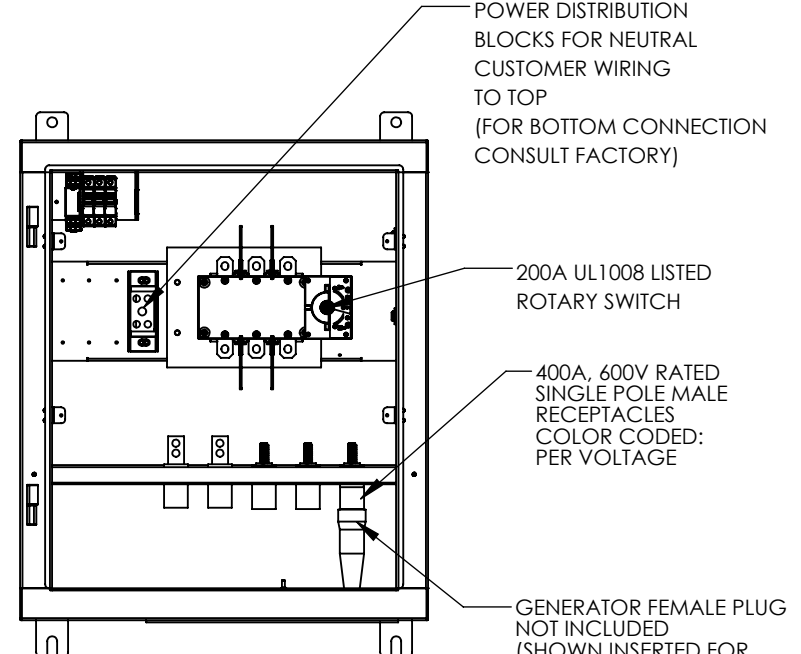

FRONT VIEW
(DOOR AND DEADFRONT REMOVED)

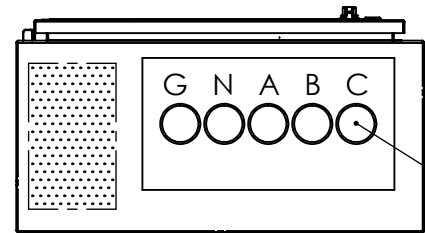

BOTTOM VIEW

HINGED INTERNAL PROTECTIVE
COVER FOR WIRE OPENING

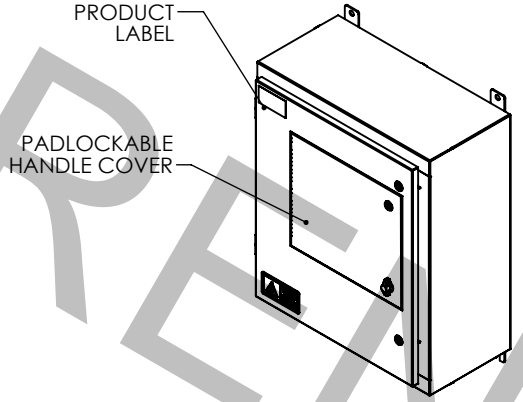

PRODUCT LABEL

PADLOCKABLE
HANDLE COVER

TERMINAL BLOCK STRIP
REMOTE START/STOP
(STANDARD)

PHASE ROTATION MONITOR & FUSES
(STANDARD)

DEADFRONT FOR
OPERATOR SAFETY
WHILE CONNECTING
AND DISCONNECTING
GENERATOR CABLES

OPERATION & SAFETY
INSTRUCTIONS

POWER DISTRIBUTION
BLOCKS FOR NEUTRAL
CUSTOMER WIRING
TO TOP
(FOR BOTTOM CONNECTION
CONSULT FACTORY)

200A UL1008 LISTED
ROTARY SWITCH

400A, 600V RATED
SINGLE POLE MALE
RECEPTACLES
COLOR CODED:
PER VOLTAGE

GENERATOR FEMALE PLUG
NOT INCLUDED
(SHOWN INSERTED FOR
SCALE PURPOSES ONLY)



ASSEMBLY NOTES

- COMPLETE ASSEMBLY IS UL LISTED AS A MANUAL TRANSFER SWITCH UNDER UL 1008 (TRANSFER SWITCH STANDARD)
- FINISH POWDER COATED SERIES W49. SEE TITLE BLOCK FOR COLOR.
- STANDARD UNIT IS NON-SWITCHED NEUTRAL. FOR SWITCHED NEUTRAL PLEASE CONSULT FACTORY.
- NOT FOR INDOOR USE
- TYPE 3R CONSTRUCTION
- OPTIONAL PLUG KITS AVAILABLE
- CONDUIT ENTRY AREA SHOWN SHADED
- FOR AVAILABLE ACCESSORIES & OPTIONS SEE SPEC SHEET**
- FOR SINGLE LINE VISIT WWW.ESLPWR.COM**

REV.	CP BY	DATE	FOR REFERENCE DESCRIPTION	
0	CP	2/10/23		
MODEL ID: 8302-SERIES			UNLESS OTHERWISE SPECIFIED: DIMENSIONS ARE IN INCHES TOLERANCES: DECIMALS .x ±.03 .XX ±.01 .XXX ±.005 ANGULAR ±1/2°	 <p>CORONA, CALIFORNIA International: (951) 739-7000 Phone: (800) 922-4188 eslpwr.com info@eslpwr.com</p>
SCHEMATIC				
THICKNESS 14GA			BREAK ALL SHARP EDGES .005 - .010	ESL ROTARYCONNECT ENCLOSURE RATED 200A
MATERIAL				
FINISH WRINKLE GRAY (RAL 7035)			DO NOT SCALE	DWG NO. 8302-SERIES
REFERENCE			PROPRIETARY	
			THIS DOCUMENT AND THE DATA DISCLOSED HEREIN OR WHEREWITH IS NOT TO BE REPRODUCED, USED OR DISCLOSED IN WHOLE OR IN PART TO ANYONE WITHOUT THE PERMISSION OF ESL.	
			EST. WEIGHT: 115 LBS.	SHEET 1 of 1